

O
B
L
I
X



OBLIX™ | PET Acoustical Ceiling Baffle

Distinctive lines create interesting simplicity. Oblix uses diagonal lines to offer a visually bold yet beautifully clean design solution to a variety of spaces – all while improving the acoustics of the space.



POLY-COUSTIX®
BY SOUND SEAL

SPECIFICATIONS

Standard Baffle Size (LxWxH): 47" x 47" x 12"
 Weight: 16 lbs.
 Fire Rating: Class A per ASTM E-84

FEATURES:

- Choice of 354 Colors
- Lightweight and Easy to Handle
- Modern Design
- Excellent Acoustical Values
- Repeatable Pattern

HARDWARE OPTIONS

Product can be installed with aircraft cable

ACOUSTICAL DATA

Frequency (Hz)	125	250	500	1000	2000	4000	SABINS
Oblix	1.17	11.31	15.60	21.20	28.71	33.39	

Frequency (Hz)	125	250	500	1000	2000	4000	NRC
Oblix	.43	.74	1.02	1.38	1.87	2.18	1.25

Based on Baffle size 4' x 4' with Type "J" Mounting. Sabins are based on Sabins per Object, NRC is an equivalent number based on one face of one panel

INSTALLATION via Aircraft Cable (see installation document)

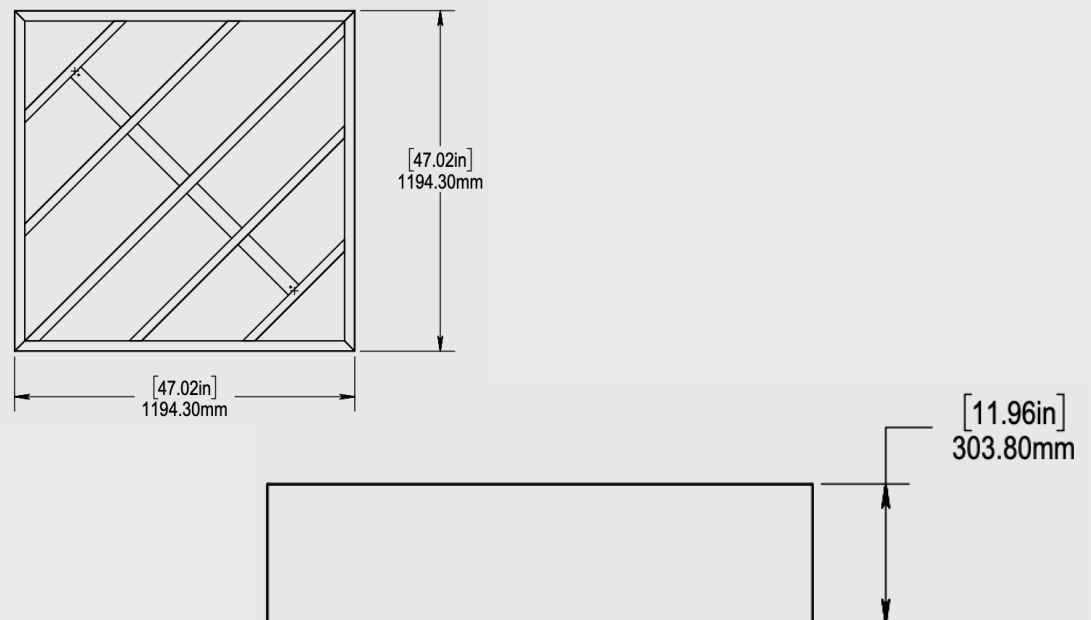

OBLIX™ | PET Acoustical Ceiling Baffle

FINISHES

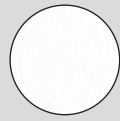

07
White



44
Ivory



42
Cream



52
Latte



53
Smoke Beige



02
Taupe

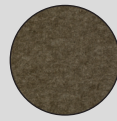

35
Speckled Earth



49
Brunette



54
Espresso



45
Big Red



43
Lava



36
Berry Red

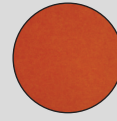

55
Tangerine



50
Caramel

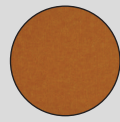

41
Marigold

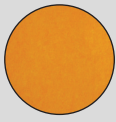

51
Sunkist Orange

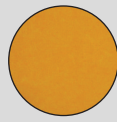

22
Yellow



39
Green Apple



12
Moss



48
Avocado

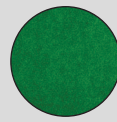

05
Dark Green



47
Emerald

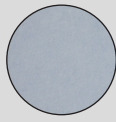

18
Arctic Ice



30
Blue

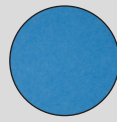

56
Azure



19
Denim



21
Indigo Blue



09
Deep Blue



08
Eggplant



03
Light Gray

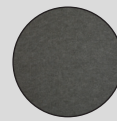

34
Pure Gray



11
Steel



17
Dark Gray



10
True Black

OBLIX™

COMPOSITION:

- 100% Polyethylene Terephthalate (PET)
- 55% recycled content

ENVIRONMENTAL FACTORS:

- 100% recyclable
- Low VOC Emissions
- LEED - MRc4



POLY-COUSTIX®
BY SOUND SEAL

A CATALYST ACOUSTICS GROUP COMPANY

SOUND SEAL®



www.soundseal.com