

1. Measure the length and height of the wall. Find center of the wall.

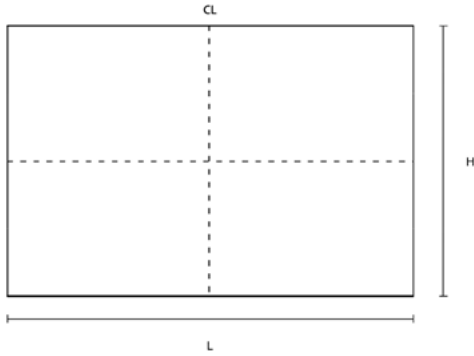

2. Lay down the TETRIX™ panels on the ground and flip the chamfered edge down.

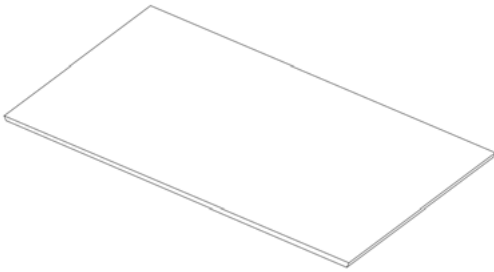

3. Use the putty knife to place the carpet adhesive to one TETRIX™ at a time. Working on one TETRIX™ at a time, apply a liberal amount of adhesive to the back of the panel utilizing the adhesive manufacturers best practices.

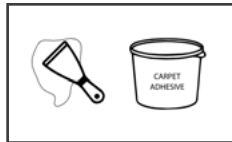
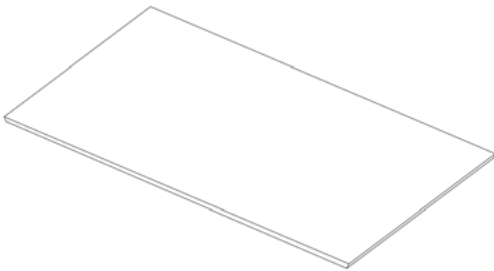

OR

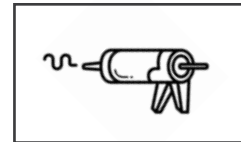

* Robert 3096 Carpet Adhesive or Liquid Nails (heavy duty)

4. Position the TETRIX™ on the wall.

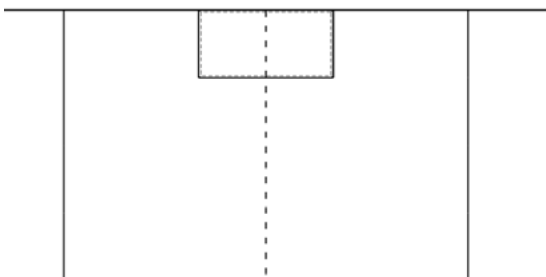

5. Use nail gun to put finishing nails on the four corners to hold the TETRIX™ until the adhesive is dry.

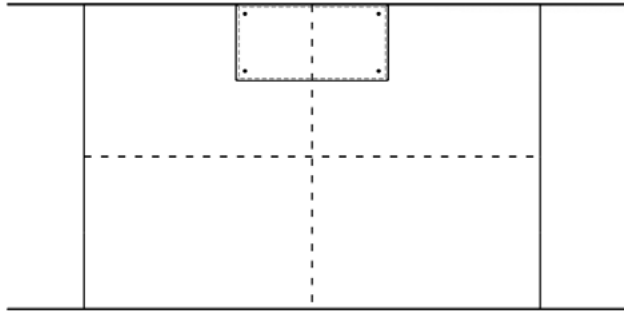
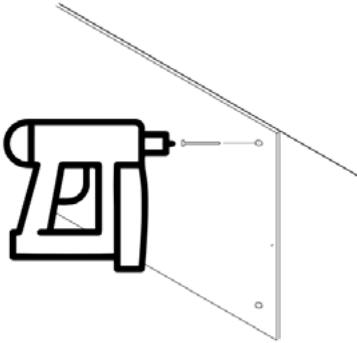

6. Use a box cutter and metal ruler to make cuts to fit the wall.

Tip for clean edges: Use smooth continued motion to cut through half the thickness of the material; using the edge of the ruler as your guide. Go over the same line again to complete the cut.

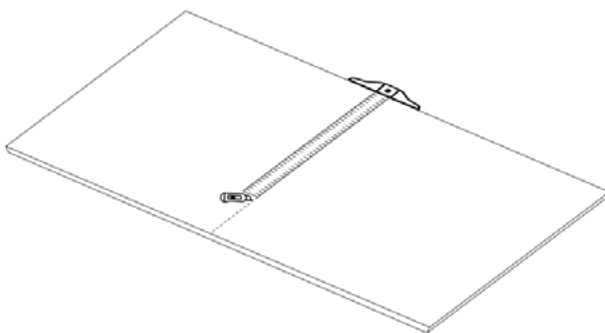
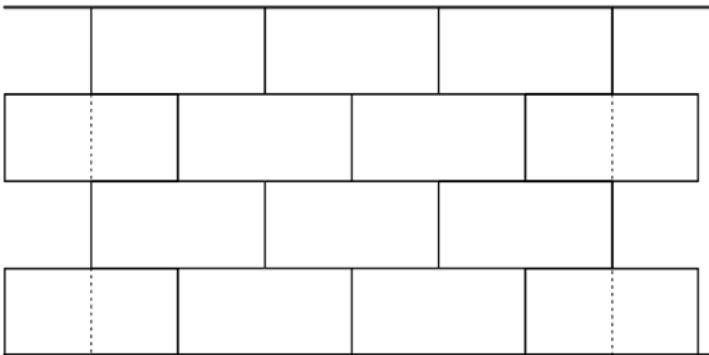

6A. Follow instructions in step #6 for cuts around outlets, etc.

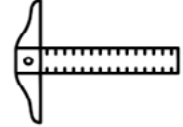
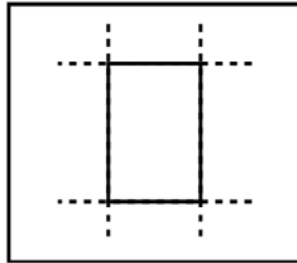
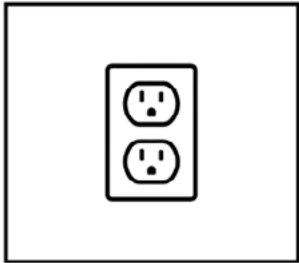

Tip: Matching paint color can be used on the wall around outlets or anywhere where TETRIX™ panels are not fitting snugly to each other. This can happen when doing complex cuts or when your wall has imperfections or is not at a perfect 90 degree angle. This small trick will stop any white wall peeking through.

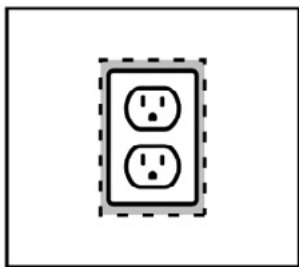

7. Once adhesive has dried, use pliers to remove the fine nails.





POLY-COUSTIX™
BY SOUND SEAL

PET I POLYESTER ACOUSTICAL PRODUCTS TETRIX™ Installation Overview

8. TETRIX™ wall is complete.

