



SOUND QUALITY
BY SOUND SEAL

BARREL DIFFUSERS | FRP & THERMO-MOLDED

STYLE COMPARISON

FRP SIZES & CONFIGURATIONS

2' FACET SIZES

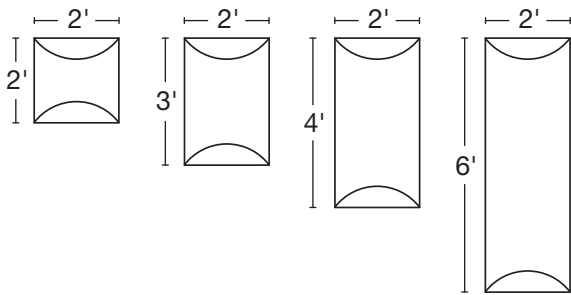

3' FACET SIZES

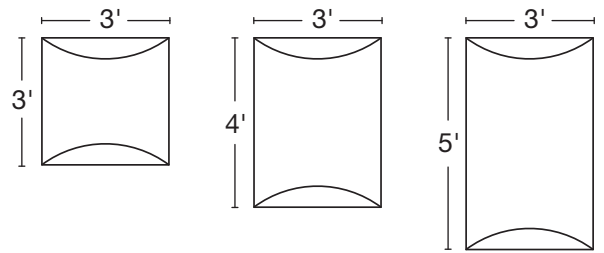

4' FACET SIZES

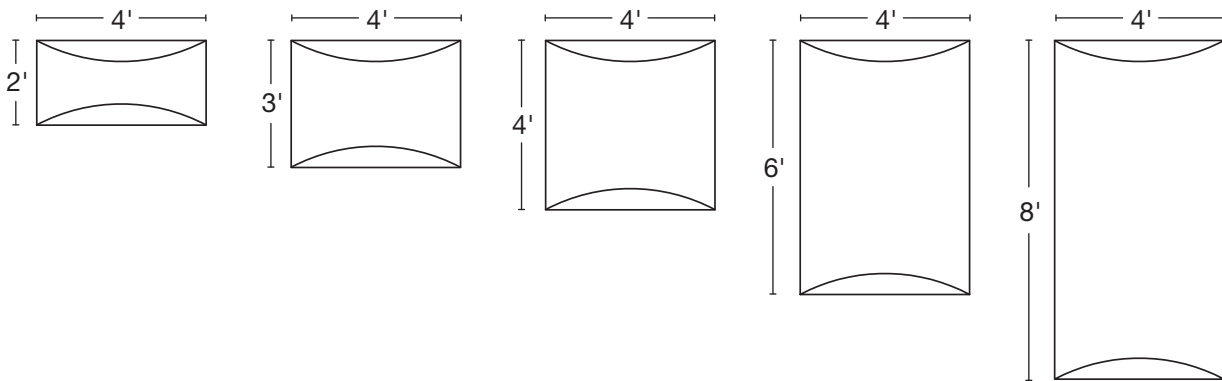

6' FACET SIZES

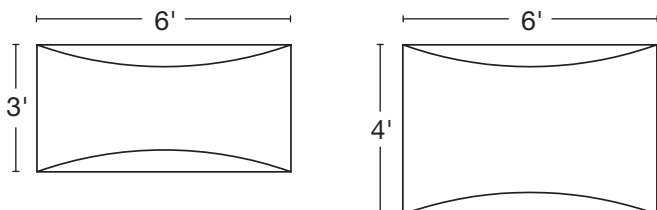

8' FACET SIZE

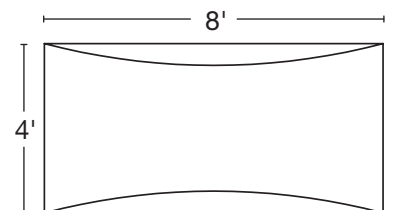



SOUND QUALITY
BY SOUND SEAL

BARREL DIFFUSERS | FRP & THERMO-MOLDED STYLE COMPARISON

THERMO-MOLDED SIZES & CONFIGURATIONS

2' FACET SIZES

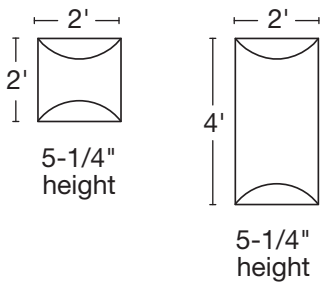

3' FACET SIZES

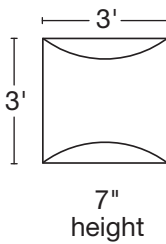

4' FACET SIZES

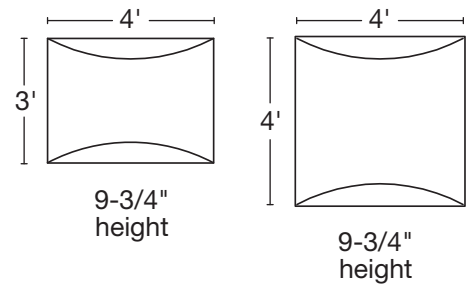

6' FACET SIZES

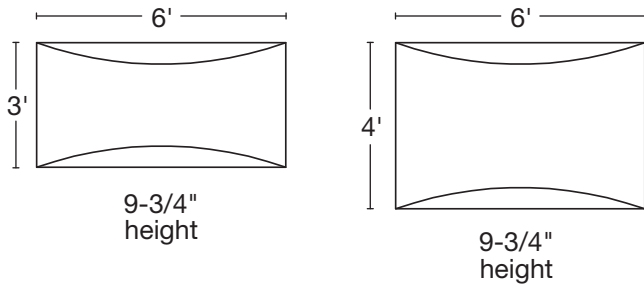

EDGE DETAIL COMPARISON

FRP DIFFUSER

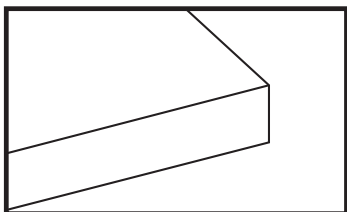

No flange (wall mount)

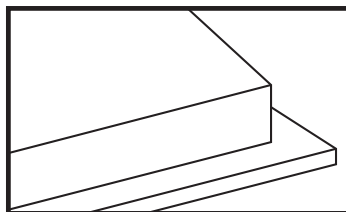

With flange (lay in ceiling mount)

THERMO-MOLDED DIFFUSER

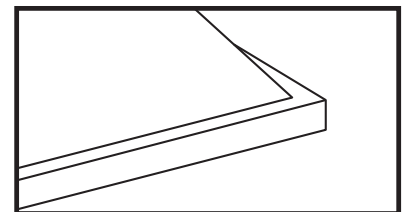

All diffusers have same edge detail for both wall and ceiling lay-in mount.